

5/22/2012 8:52:43 PM

NOTE: These pages contain confidential trade secrets of WAM and/or the client addressed. They are intended only for use of the individual or entity to which it is addressed and may contain information that is privileged, confidential, and exempt from disclosure under applicable law. You are hereby notified that any dissemination, distribution or copying of this document is strictly prohibited.

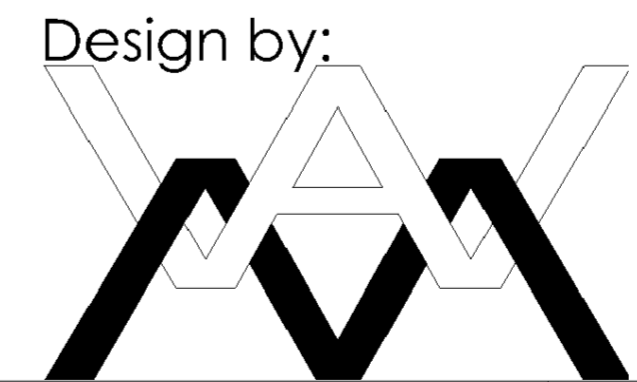

Design by:  
**WAM**  
7839 Sabre Court Road  
Manassas, VA 20109  
Tele: 703-392-8575  
Fax: 703-392-6911

Title		dropwr.SCHDOC	
Size	Number	Revision	
B	1	0	A
Date:	5/22/2012	Sheet 0 of 0	
File:	H:\AJAWAM\...\dropwr.SCHDOC	Drawn By:	

MT1

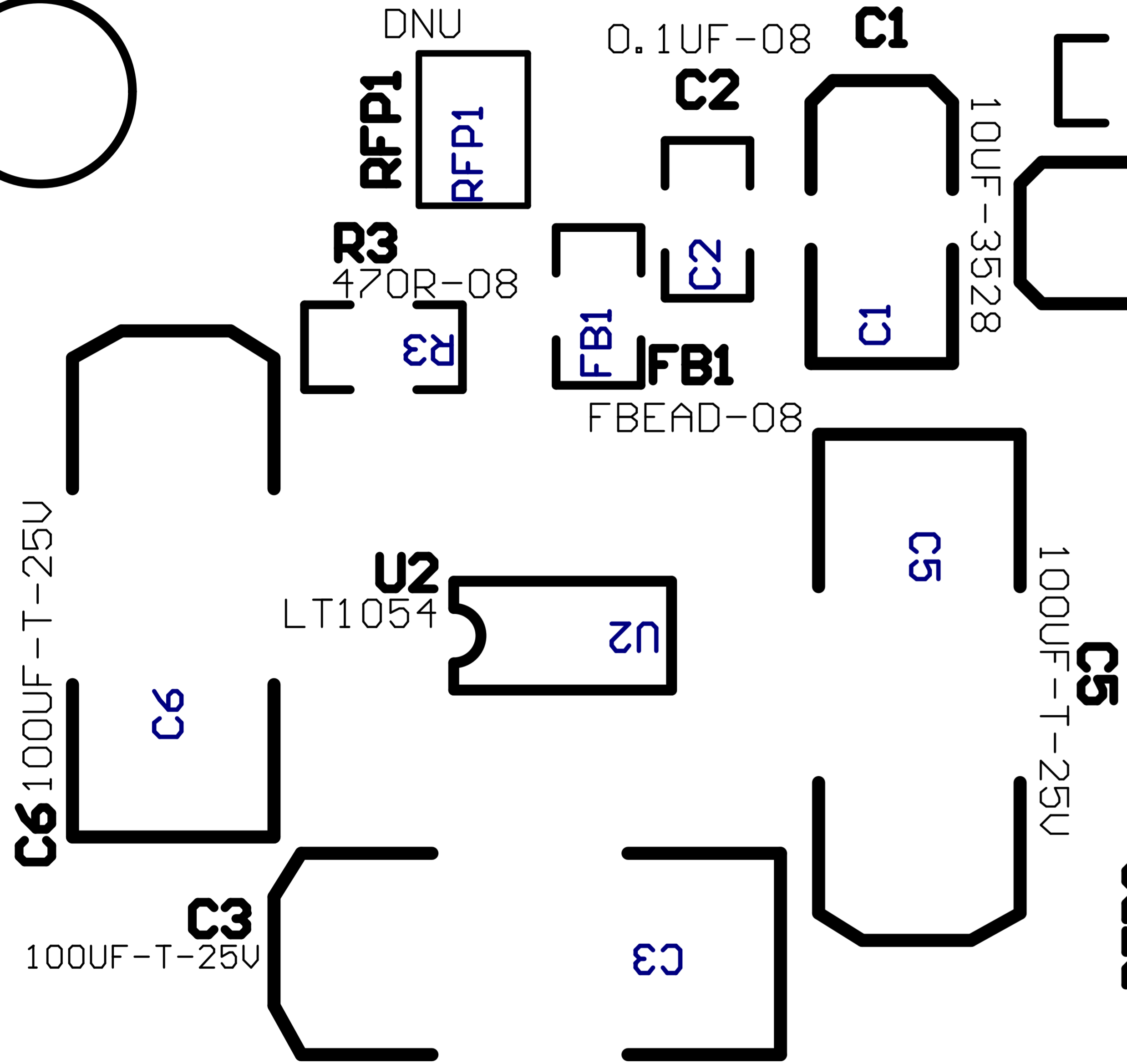
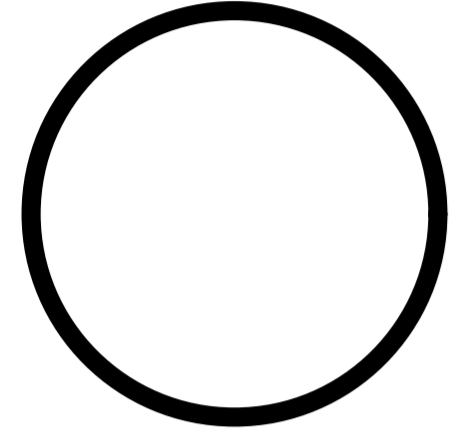

MT2

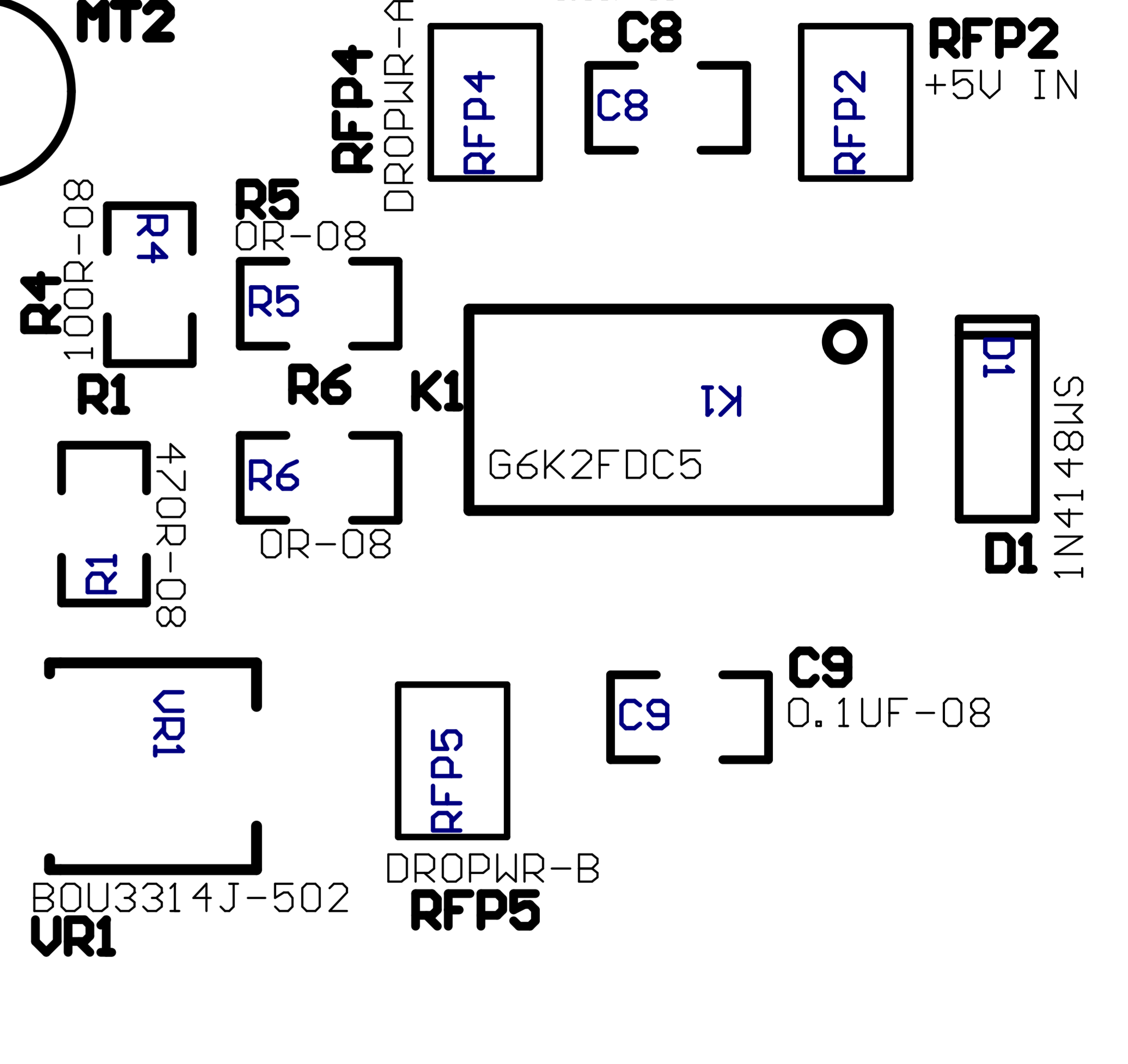
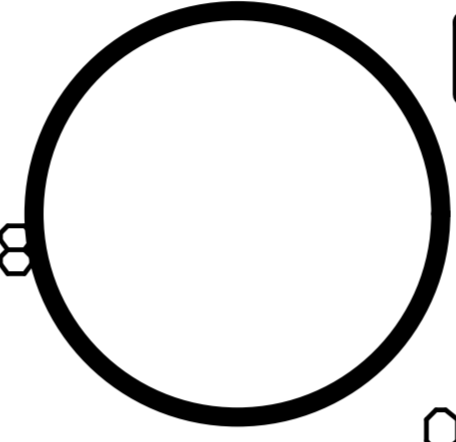



MT1

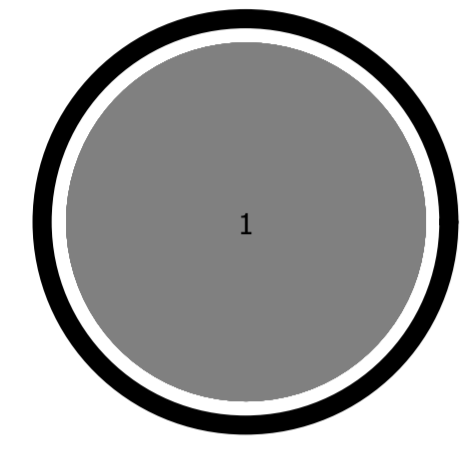

MT2

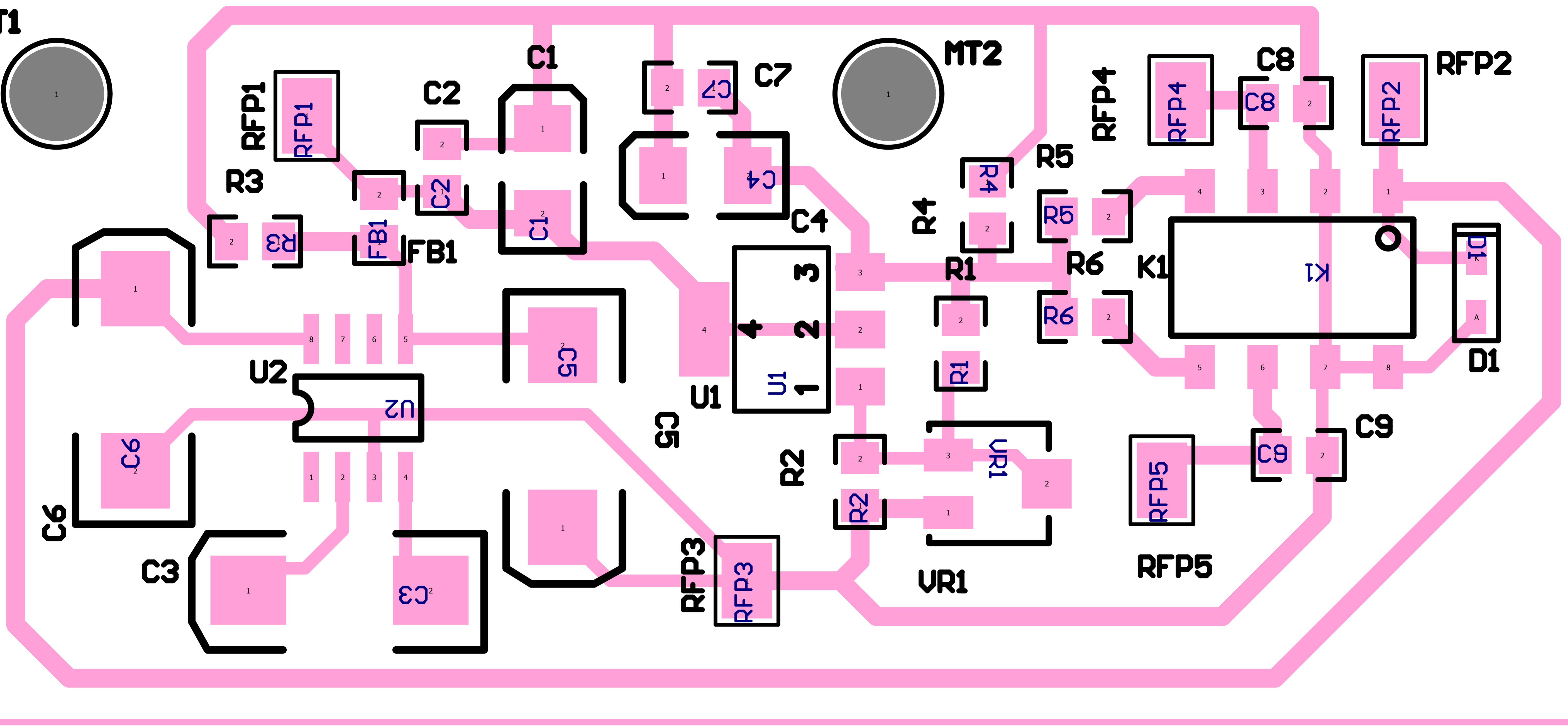
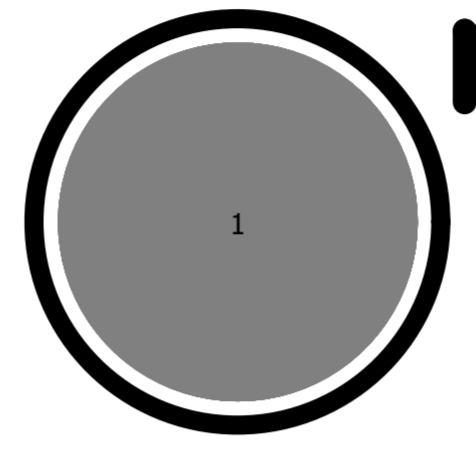

RFP1

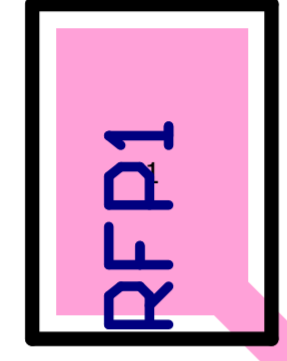

C2

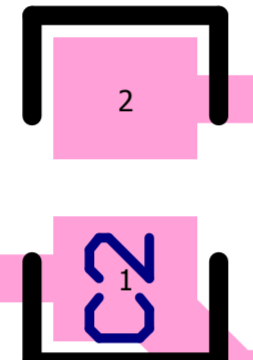

C1

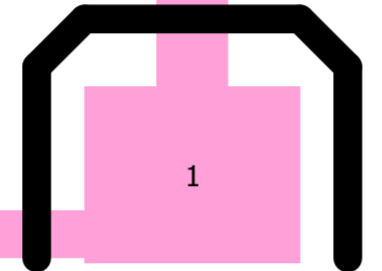

C7

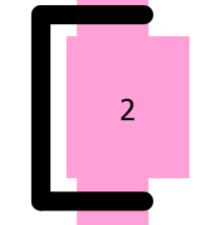

C4

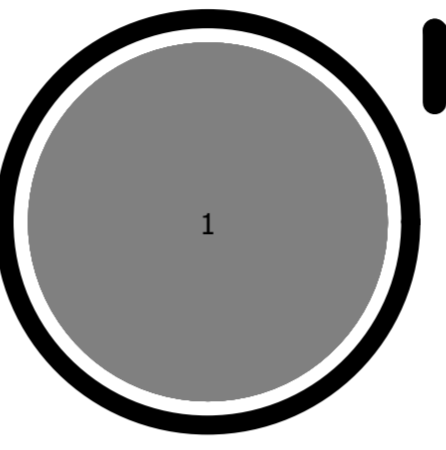
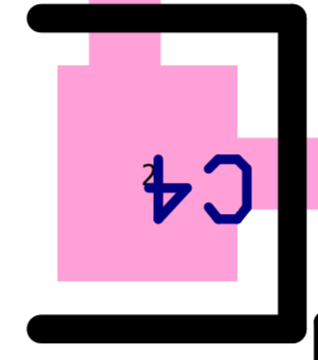

RFP4

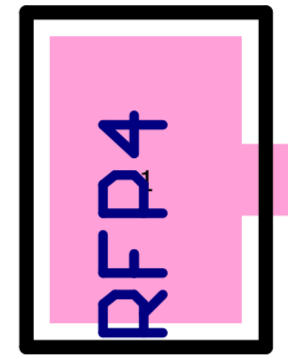

C8

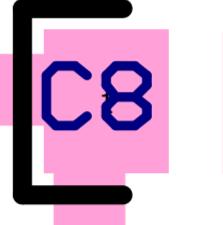

RFP2

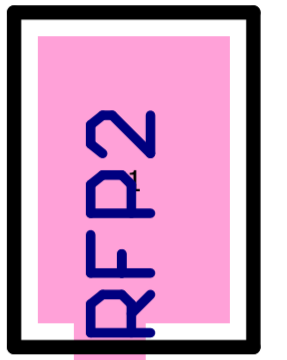

R3

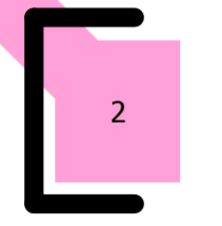

FB1

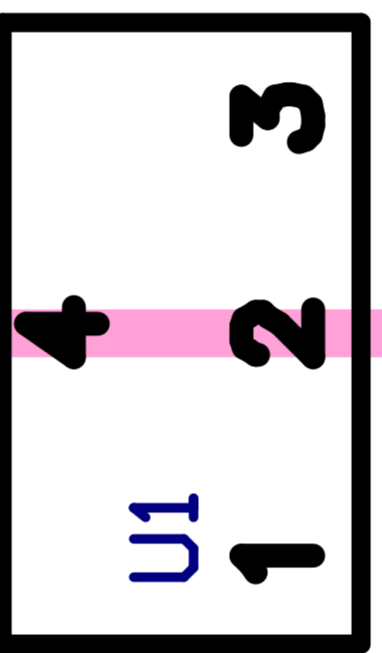
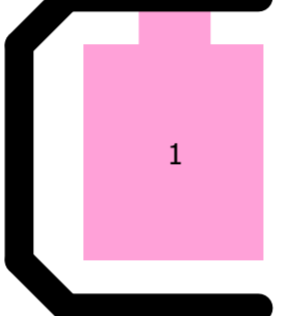
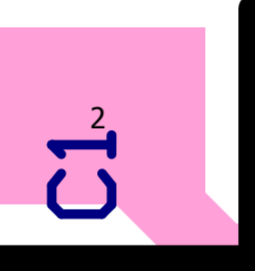
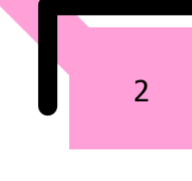

R4

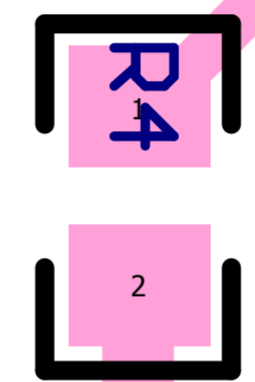

R5



R6

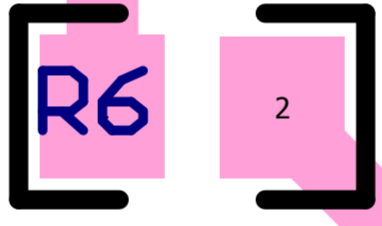

K1

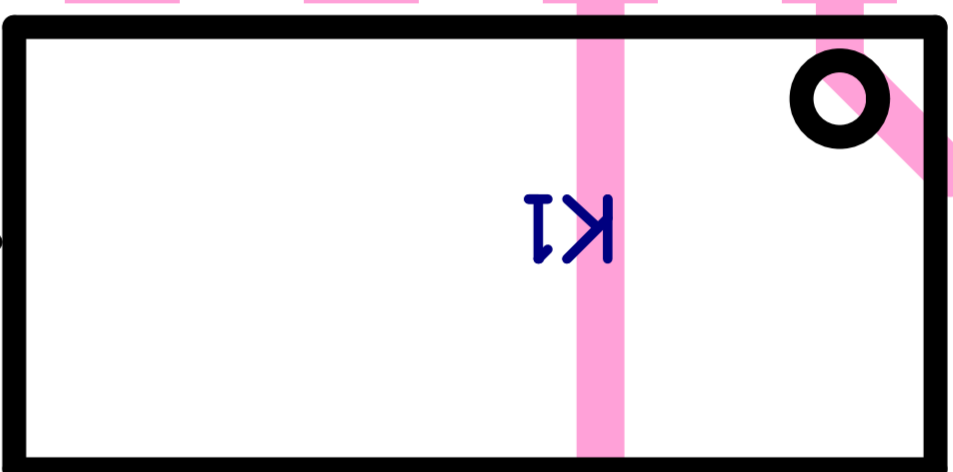

D1

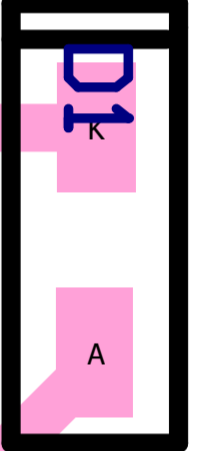

U2

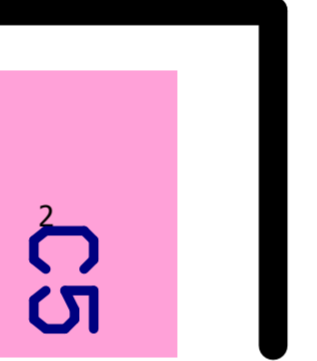
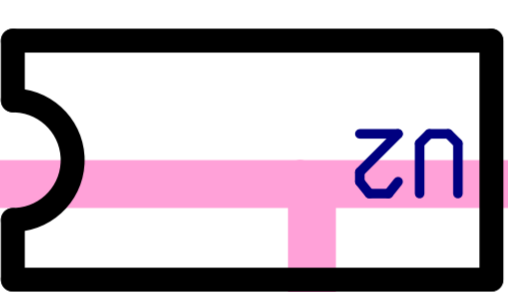

C5

U1

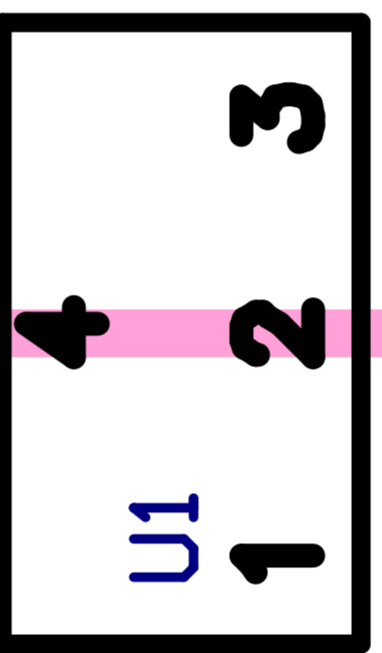

R1

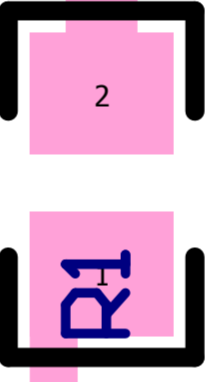

R6

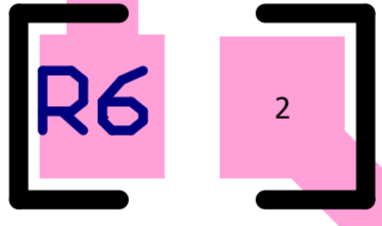

K1

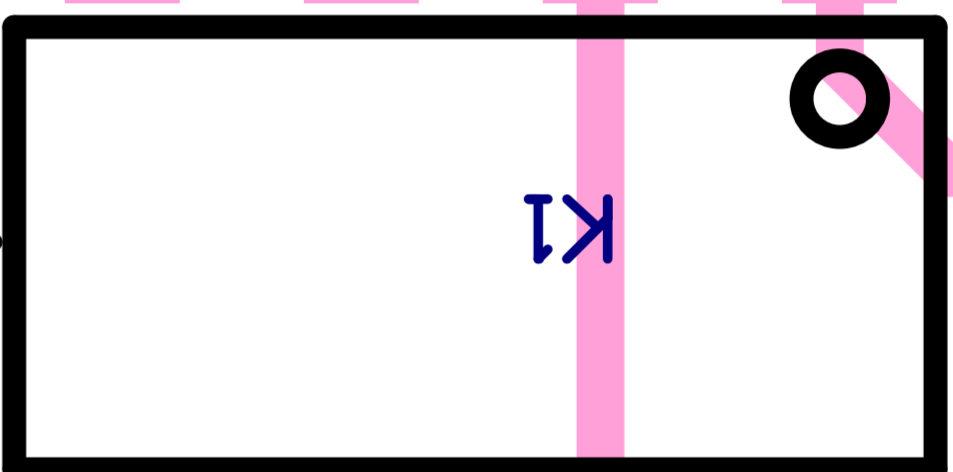

D1

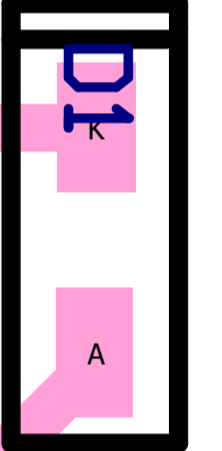

C6

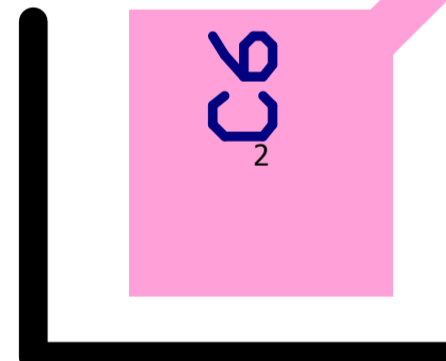

C3

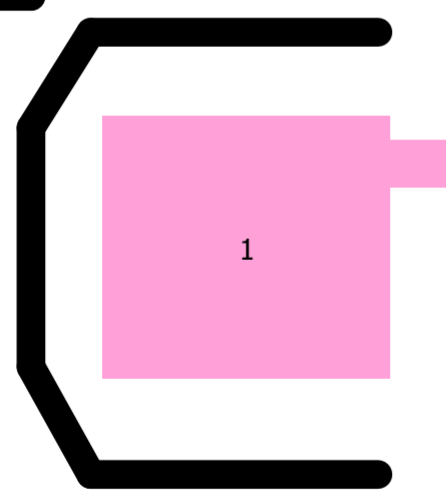

C3

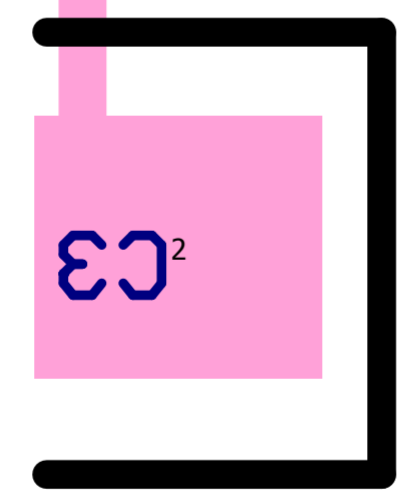

RFP3

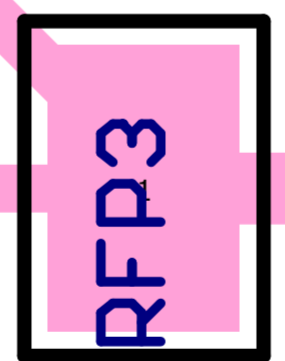

R2

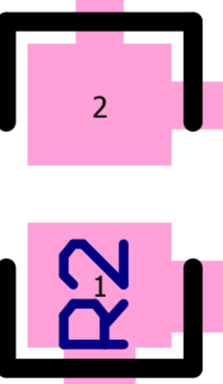

UR1

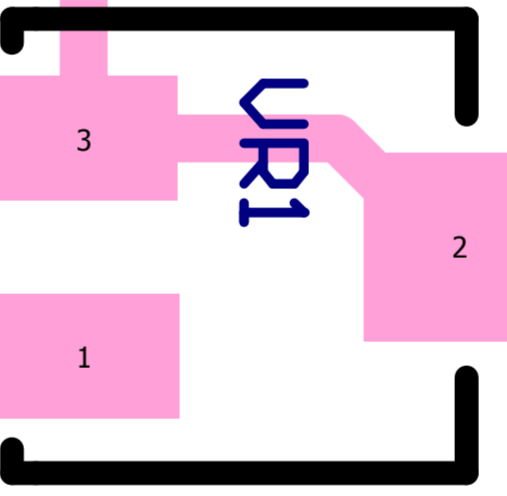

RFP5

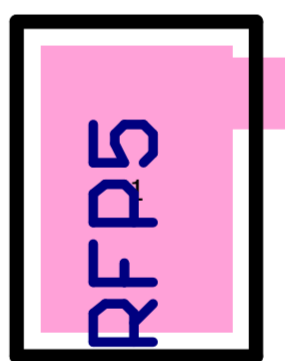

C9

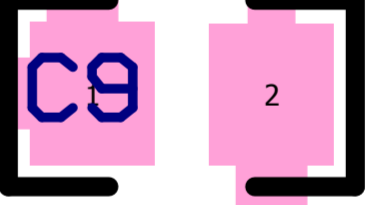

C9